











BT-71/BT-60B/BT-48B TROLLEY

INSTRUCCIONES DE MONTAJE

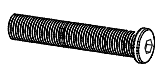
ASSEMBLY INSTRUCTIONS

INSTRUCTIONS D'ASSEMBLÉE

Part list

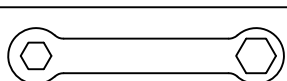
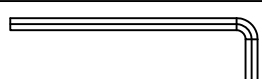
Part no.	Drawing	Description	Qty.
A		Asa Handle Poignée	1
B		Protección anticaída Enclosure pole Protección lateral	2
C		Base Base Base	1
D1		Rueda de dirección fija con freno Fixed-direction wheel with brake Roue fixe avec frein	2
D2		Rueda giratoria con freno Swivel wheel with brake Roue pivotante avec frein	2
E		Tomillo Bolt Vis	12
F		Tuerca Nut Écrou	12
G		Cinta Belt Bande élastique	1
H		Tuerca Nut Écrou	16
I		Arandela de acero Steel washer Rondelle d'acier	32
J		Tomillo Bolt Vis	16
K		Llave inglesa Spanner Clé	2
L		Llave Allen Allen wrench Clé Allen	1

PASO 1: Primeramente colocar I en J, unir luego D1/D2 con J&I X 4 piezas, luego juntar I X 4 piezas y H X 4 piezas en C. Repetir el ensamblaje para las cuatro ruedas.

STEP 1: Put I on J firstly, assemble D1/D2 with J&I X4 pcs, another I X 4 pcs and H X 4 pcs to C. Repeat the assembling for the four wheels.

ETAPE 1: Mettez I et J premièrement, assemblez D1/D2 avec J&I X 4 pièces, ajoutez I X 4 pièces et H X 4 pièces à C. Répétez et assemblez les quatre roues à la base.

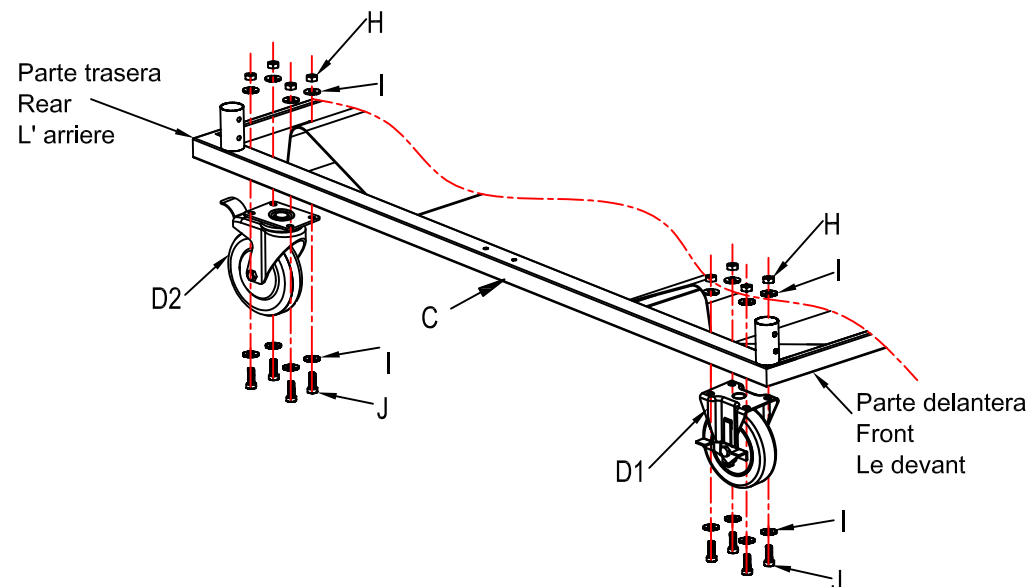

PASO 2: Unir B X 2 piezas con E X 12 piezas en C, prestar atención en diferenciar entre la parte trasera y delantera de C, la parte trasera de B tiene que anclarse en la parte trasera de C.

STEP 2: Assemble B X2pcs with E X 12pcs and F X12pcs to C , pay attention to differentiate between rear and front of C , the rear of B must be fitted to the rear of C.

ETAPE 2: Assemblez B X 2 pièces avec E X 12 pièces à C, faire l'attention pour différencier entre l'arrière et le devant de C, l'arrière de B doit être ajusté à l'arrière de C.

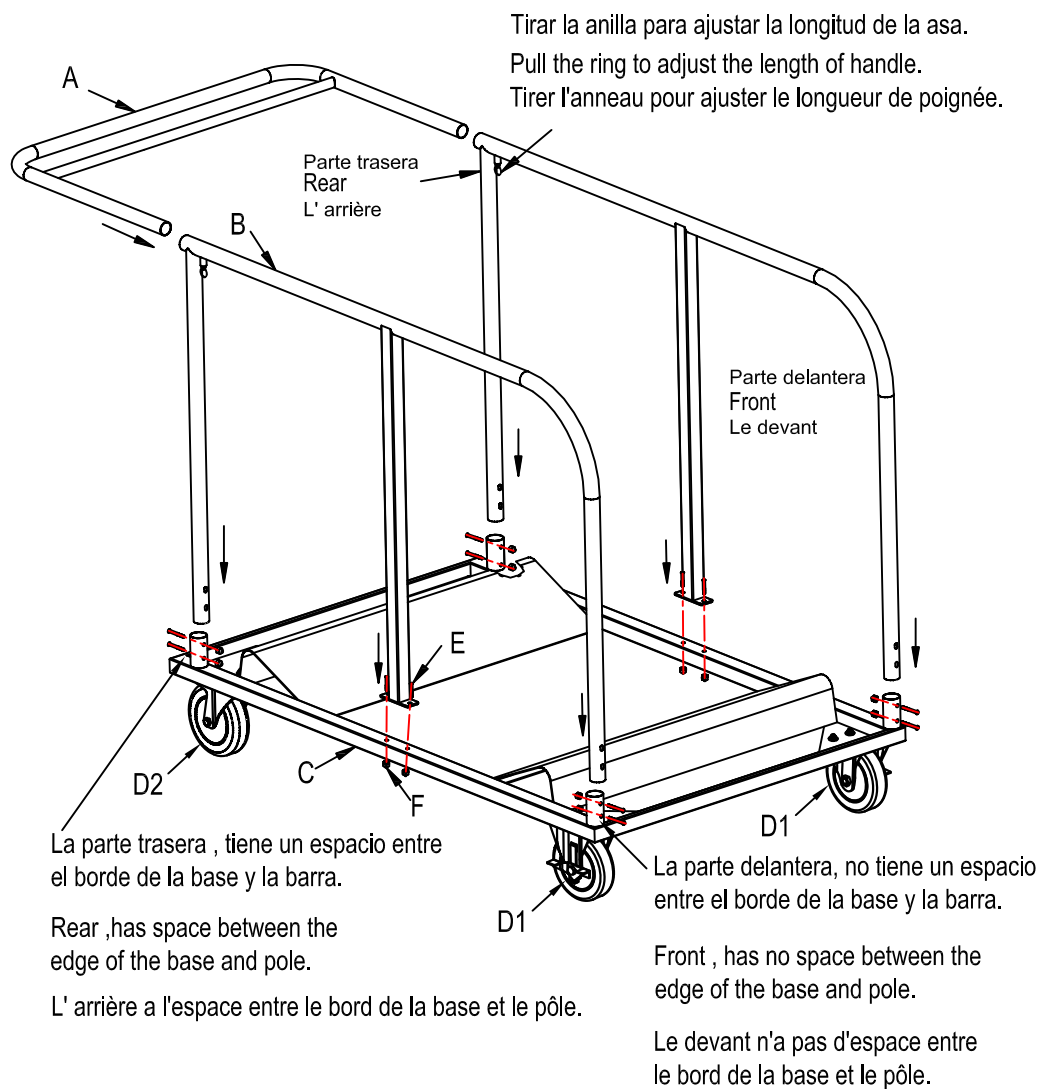

Utilizar la cinta para fijar las mesas cuando estas no llenan el carro.

Use attached belt to fix the table when the table is not full fill the trolley .

Utilisez la bande élastique pour fixer les tables quand le charriot n'est pas plein de tables.

